

## Parts & Accessories Diagram - Model HJE960-CE

**PROPRIETARY RIGHTS NOTICE** This document and all information contained within it is the property of Hamilton Beach Brands, Inc. (HBB). It is confidential and proprietary and has been provided to you for a limited purpose. It must be returned or destroyed upon request. Disclosure, reproduction or use of this document and any information contained within it, in full or in part, for any purpose is forbidden without the prior written consent of HBB. No photographs may be taken of any article fabricated or assembled from this document without the prior written consent of HBB.

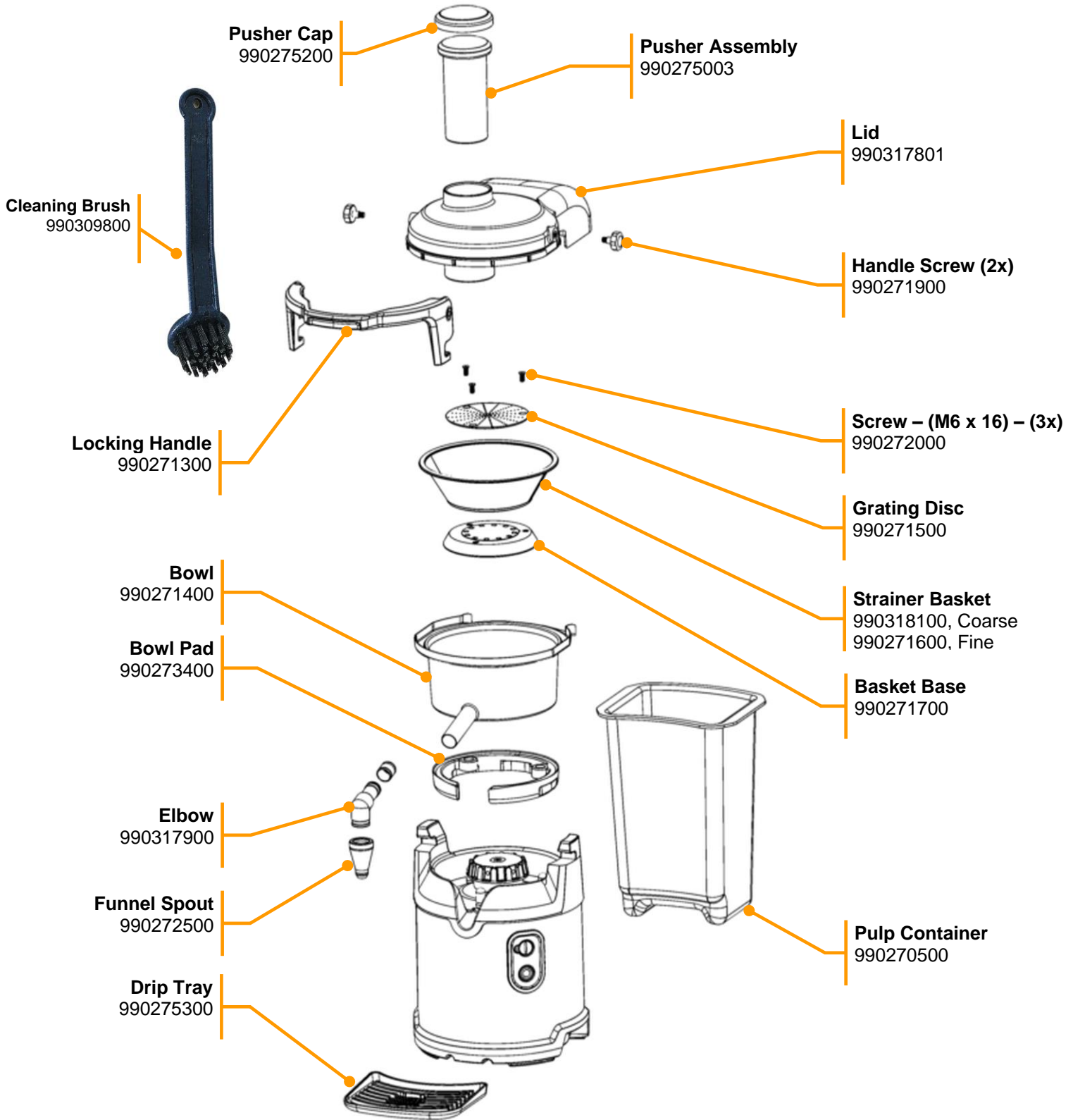

 4421 Waterfront Drive Glen Allen, VA 23060	Revision Description:	Add SB960 and SB961 images and call outs to PAD.				Rev. Date:
	Request #:	DOC11607	Page:	1 of 17	Document #:	540096100
						Rev: J

## Parts & Accessories Diagram - Model HJE960-CE

**PROPRIETARY RIGHTS NOTICE** This document and all information contained within it is the property of Hamilton Beach Brands, Inc. (HBB). It is confidential and proprietary and has been provided to you for a limited purpose. It must be returned or destroyed upon request. Disclosure, reproduction or use of this document and any information contained within it, in full or in part, for any purpose is forbidden without the prior written consent of HBB. No photographs may be taken of any article fabricated or assembled from this document without the prior written consent of HBB.

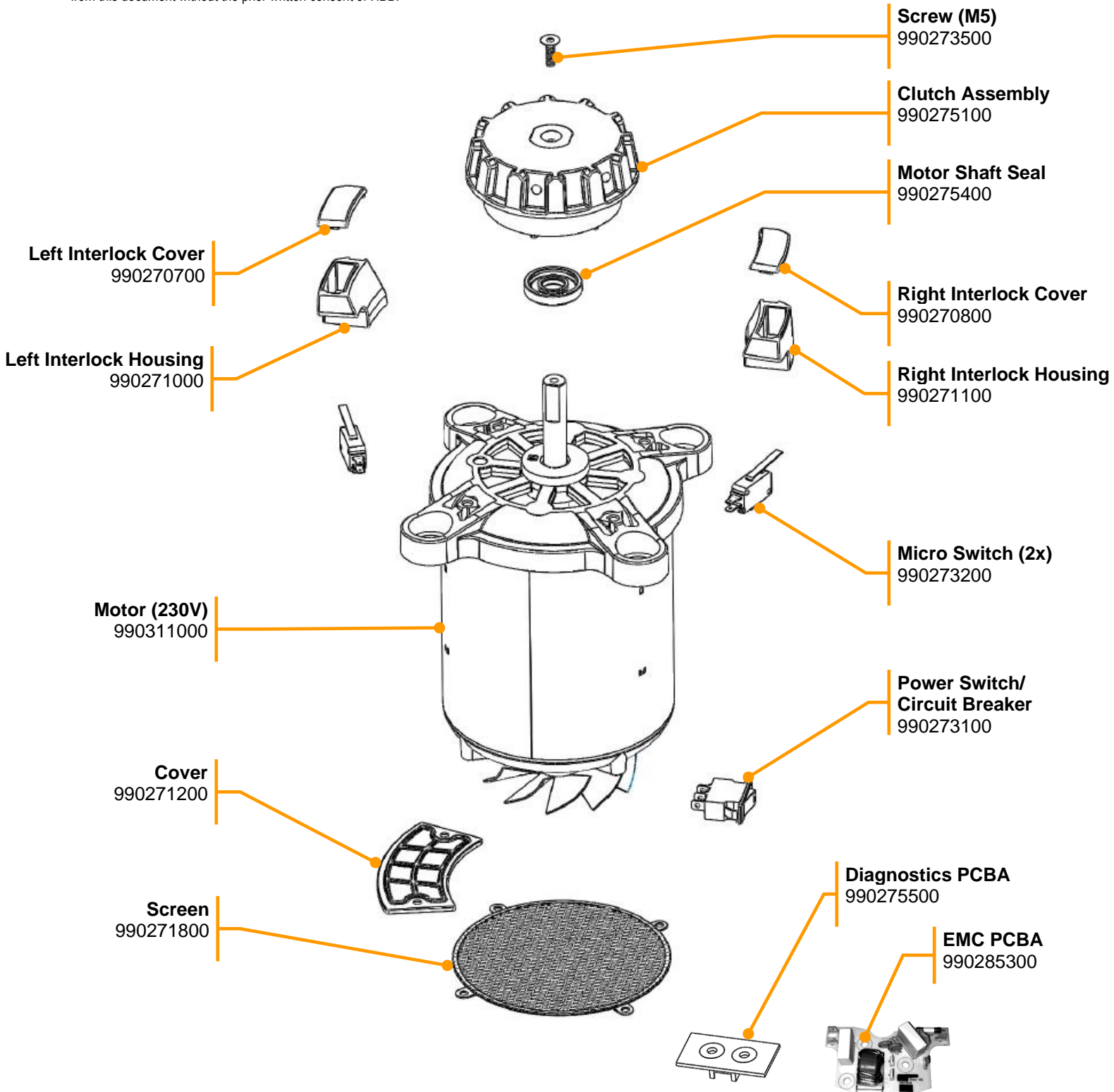



 4421 Waterfront Drive Glen Allen, VA 23060	Revision Description:	Add SB960 and SB961 images and call outs to PAD.				Rev. Date:
	Request #:	DOC11607	Page:	2 of 17	Document #:	540096100
						Rev: J

## Parts & Accessories Diagram - Model HJE960-CE

**PROPRIETARY RIGHTS NOTICE** This document and all information contained within it is the property of Hamilton Beach Brands, Inc. (HBB). It is confidential and proprietary and has been provided to you for a limited purpose. It must be returned or destroyed upon request. Disclosure, reproduction or use of this document and any information contained within it, in full or in part, for any purpose is forbidden without the prior written consent of HBB. No photographs may be taken of any article fabricated or assembled from this document without the prior written consent of HBB.

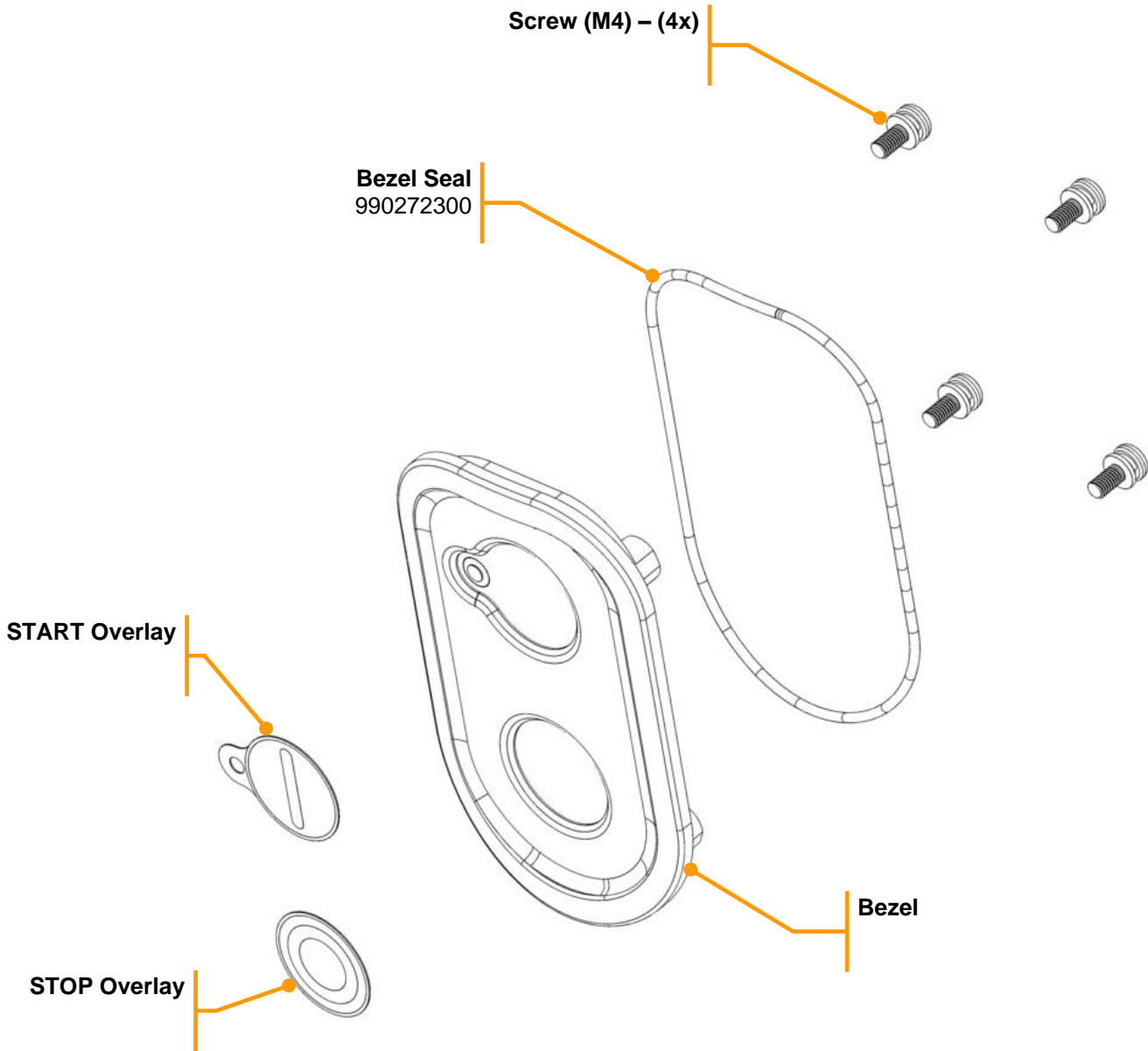
990273700 Bezel Service Kit – Includes all components as pictured below



 4421 Waterfront Drive Glen Allen, VA 23060	Revision	Add SB960 and SB961 images and call outs to PAD.				Rev. Date:	
	Description:					Rev. Date:	
Request #:	DOC11607	Page:	3 of 17	Document #:	540096100	Rev:	J

## Parts & Accessories Diagram - Model HJE960-CE

**PROPRIETARY RIGHTS NOTICE** This document and all information contained within it is the property of Hamilton Beach Brands, Inc. (HBB). It is confidential and proprietary and has been provided to you for a limited purpose. It must be returned or destroyed upon request. Disclosure, reproduction or use of this document and any information contained within it, in full or in part, for any purpose is forbidden without the prior written consent of HBB. No photographs may be taken of any article fabricated or assembled from this document without the prior written consent of HBB.

990273800 Latch Service Kit – Includes all components as pictured below

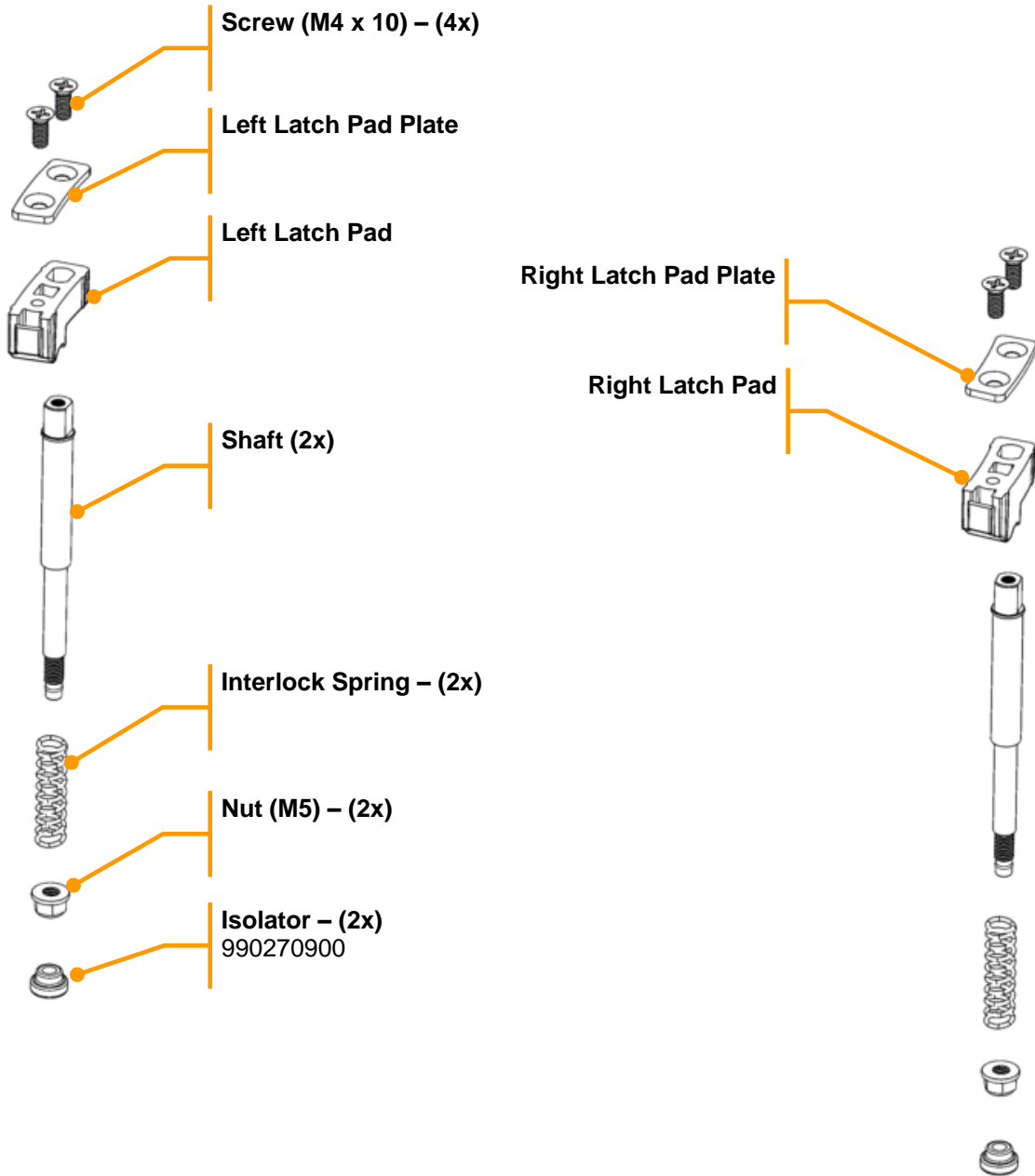



 4421 Waterfront Drive Glen Allen, VA 23060	Revision	Add SB960 and SB961 images and call outs to PAD.					Rev. Date:
	Description:						Rev. Date:
Request #:	DOC11607	Page:	4 of 17	Document #:	<b>540096100</b>	Rev:	<b>J</b>

## Parts & Accessories Diagram - Model HJE960-CE

**PROPRIETARY RIGHTS NOTICE** This document and all information contained within it is the property of Hamilton Beach Brands, Inc. (HBB). It is confidential and proprietary and has been provided to you for a limited purpose. It must be returned or destroyed upon request. Disclosure, reproduction or use of this document and any information contained within it, in full or in part, for any purpose is forbidden without the prior written consent of HBB. No photographs may be taken of any article fabricated or assembled from this document without the prior written consent of HBB.

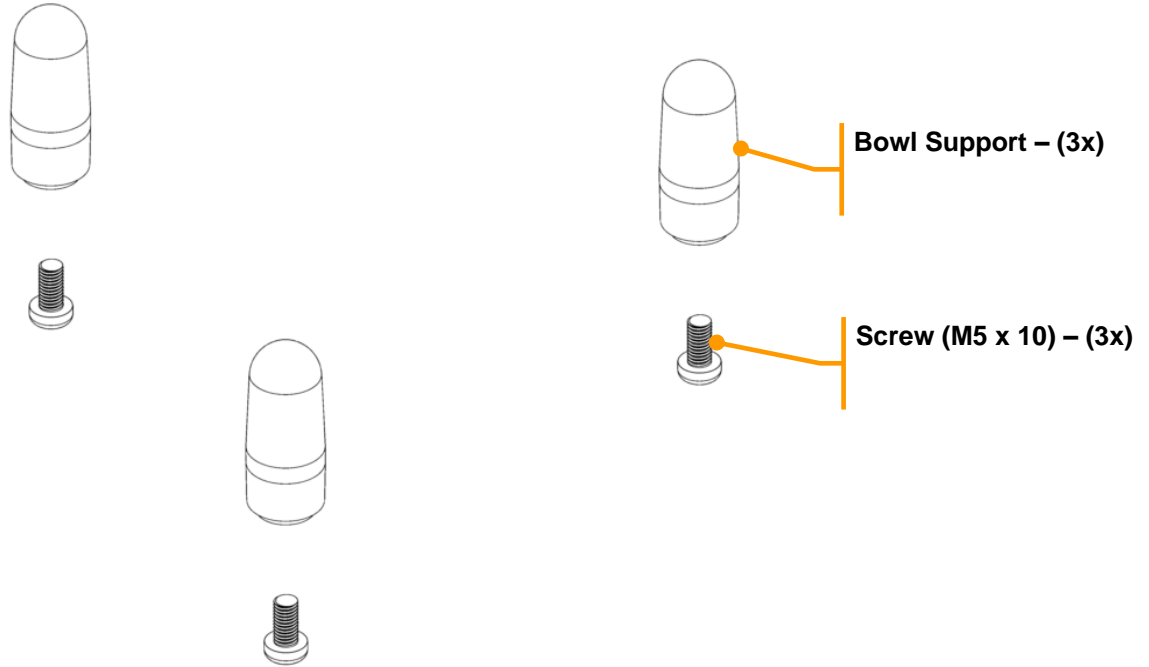
### 990273900 Bowl Support Service Kit – Includes all components as pictured below





 4421 Waterfront Drive Glen Allen, VA 23060	Revision	Add SB960 and SB961 images and call outs to PAD.					Rev. Date:	
	Description:						Rev. Date:	
Request #:	DOC11607	Page:	5 of 17	Document #:	<b>540096100</b>	Rev:	<b>J</b>	

## Parts & Accessories Diagram - Model HJE960-CE

**PROPRIETARY RIGHTS NOTICE** This document and all information contained within it is the property of Hamilton Beach Brands, Inc. (HBB). It is confidential and proprietary and has been provided to you for a limited purpose. It must be returned or destroyed upon request. Disclosure, reproduction or use of this document and any information contained within it, in full or in part, for any purpose is forbidden without the prior written consent of HBB. No photographs may be taken of any article fabricated or assembled from this document without the prior written consent of HBB.

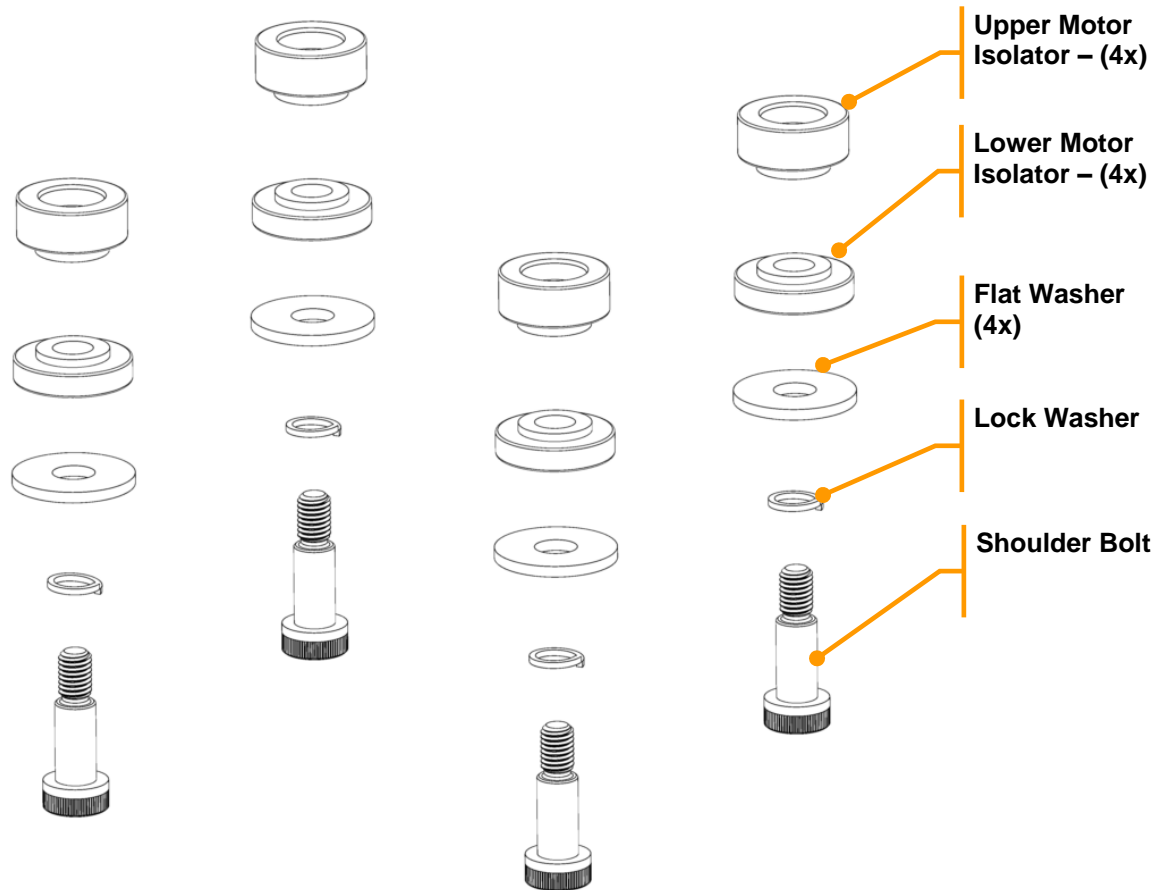
### 990274000 Motor Hardware Kit – Includes all components as pictured below



 4421 Waterfront Drive Glen Allen, VA 23060	Revision	Add SB960 and SB961 images and call outs to PAD.				Rev. Date:	
	Description:					04/02/2021	
Request #:	DOC11607	Page:	6 of 17	Document #:	<b>540096100</b>	Rev:	<b>J</b>

## Parts & Accessories Diagram - Model HJE960-CE

**PROPRIETARY RIGHTS NOTICE** This document and all information contained within it is the property of Hamilton Beach Brands, Inc. (HBB). It is confidential and proprietary and has been provided to you for a limited purpose. It must be returned or destroyed upon request. Disclosure, reproduction or use of this document and any information contained within it, in full or in part, for any purpose is forbidden without the prior written consent of HBB. No photographs may be taken of any article fabricated or assembled from this document without the prior written consent of HBB.

### 990274101 Rubber Foot Kit – Includes all components as pictured below

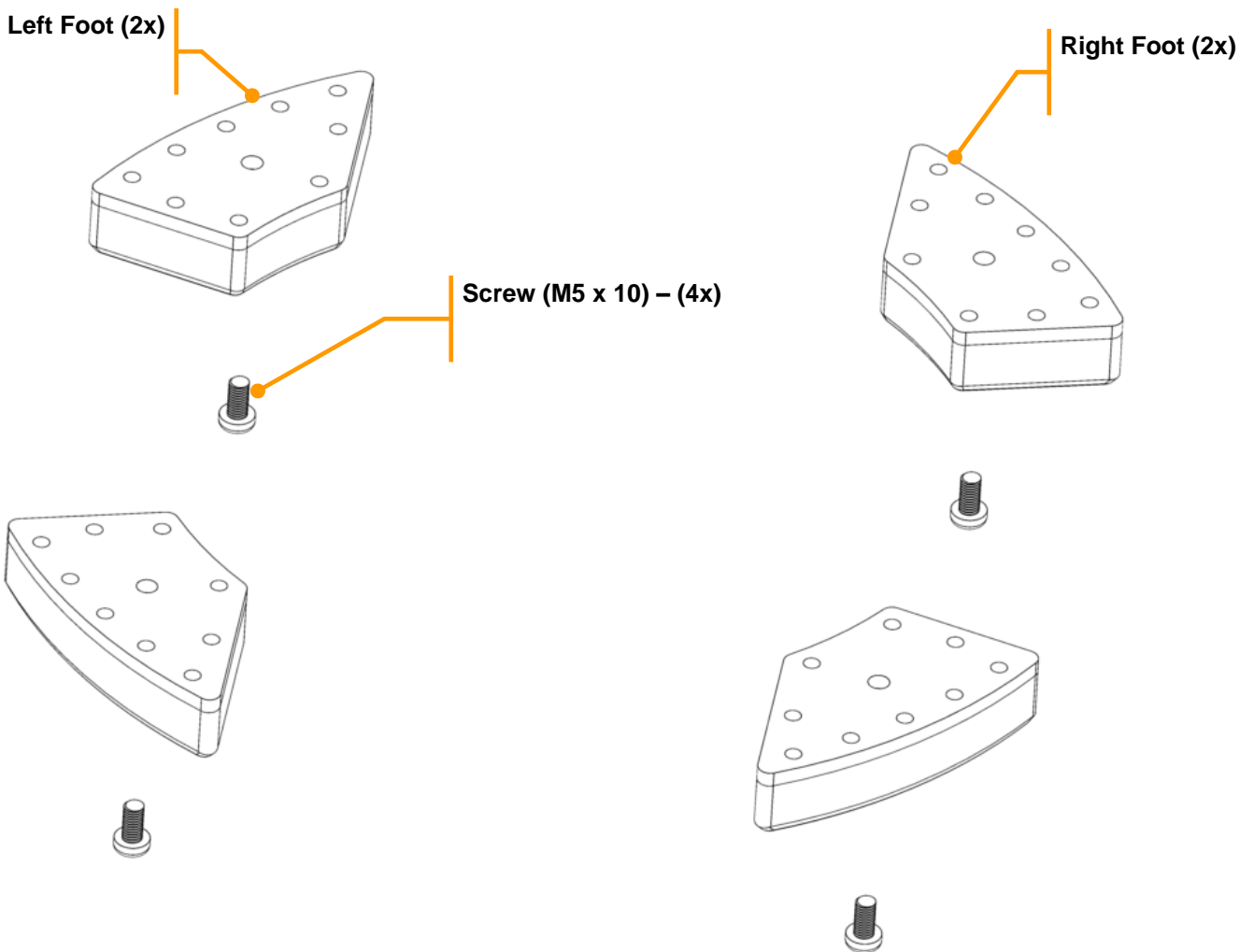



 4421 Waterfront Drive Glen Allen, VA 23060	Revision	Add SB960 and SB961 images and call outs to PAD.				Rev. Date:	
	Description:					04/02/2021	
Request #:	DOC11607	Page:	7 of 17	Document #:	<b>540096100</b>	Rev:	<b>J</b>

## Parts & Accessories Diagram - Model HJE960-CE

**PROPRIETARY RIGHTS NOTICE** This document and all information contained within it is the property of Hamilton Beach Brands, Inc. (HBB). It is confidential and proprietary and has been provided to you for a limited purpose. It must be returned or destroyed upon request. Disclosure, reproduction or use of this document and any information contained within it, in full or in part, for any purpose is forbidden without the prior written consent of HBB. No photographs may be taken of any article fabricated or assembled from this document without the prior written consent of HBB.

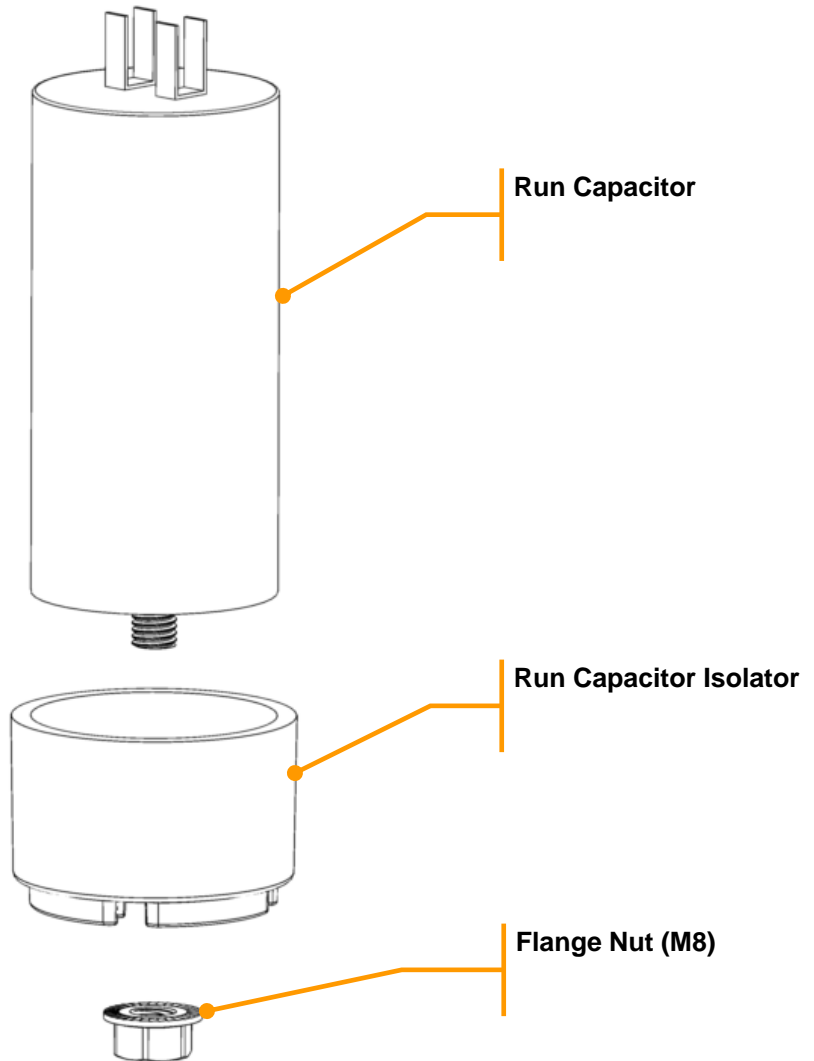
990274201 **Run Capacitor Kit** – Includes all components as pictured below



 4421 Waterfront Drive Glen Allen, VA 23060	Revision	Add SB960 and SB961 images and call outs to PAD.				Rev. Date:	
	Description:					04/02/2021	
Request #:	DOC11607	Page:	8 of 17	Document #:	<b>540096100</b>	Rev:	<b>J</b>



## Parts & Accessories Diagram - Model HJE960-CE

**PROPRIETARY RIGHTS NOTICE** This document and all information contained within it is the property of Hamilton Beach Brands, Inc. (HBB). It is confidential and proprietary and has been provided to you for a limited purpose. It must be returned or destroyed upon request. Disclosure, reproduction or use of this document and any information contained within it, in full or in part, for any purpose is forbidden without the prior written consent of HBB. No photographs may be taken of any article fabricated or assembled from this document without the prior written consent of HBB.

990274301 Start Capacitor Kit – Includes all components as pictured below

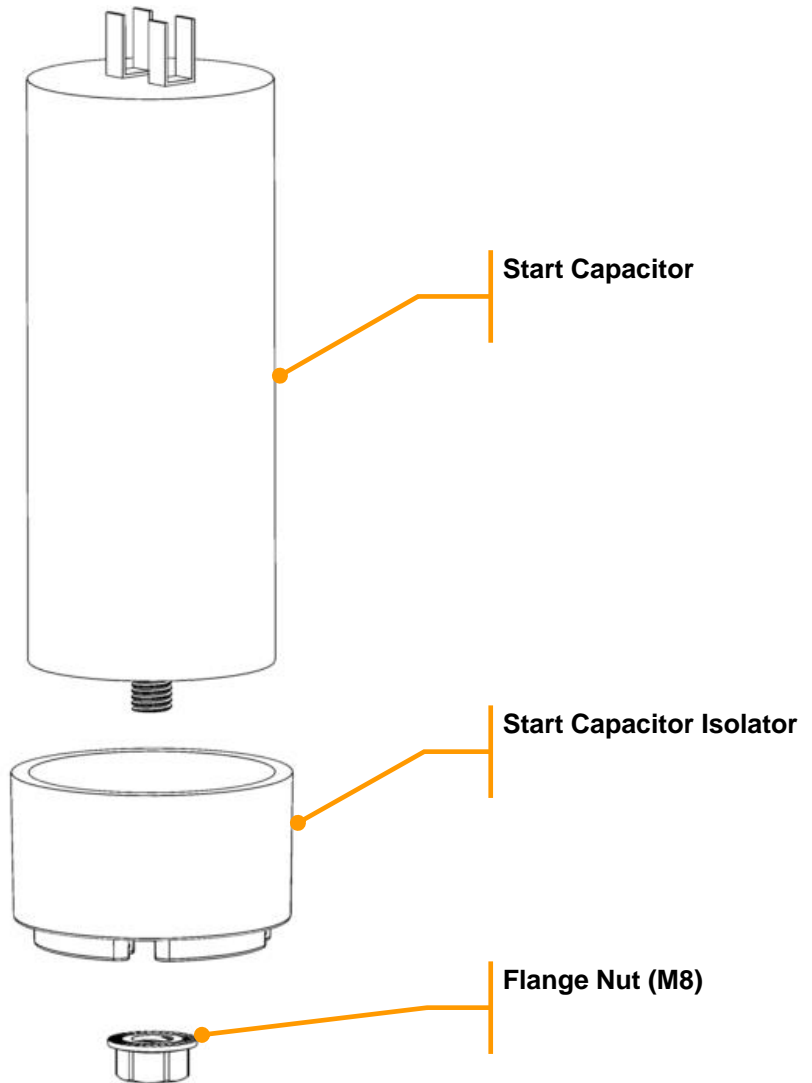



 4421 Waterfront Drive Glen Allen, VA 23060	Revision	Add SB960 and SB961 images and call outs to PAD.				Rev. Date:	
	Description:					04/02/2021	
Request #:	DOC11607	Page:	9 of 17	Document #:	<b>540096100</b>	Rev:	<b>J</b>

## Parts & Accessories Diagram - Model HJE960-CE

**PROPRIETARY RIGHTS NOTICE** This document and all information contained within it is the property of Hamilton Beach Brands, Inc. (HBB). It is confidential and proprietary and has been provided to you for a limited purpose. It must be returned or destroyed upon request. Disclosure, reproduction or use of this document and any information contained within it, in full or in part, for any purpose is forbidden without the prior written consent of HBB. No photographs may be taken of any article fabricated or assembled from this document without the prior written consent of HBB.

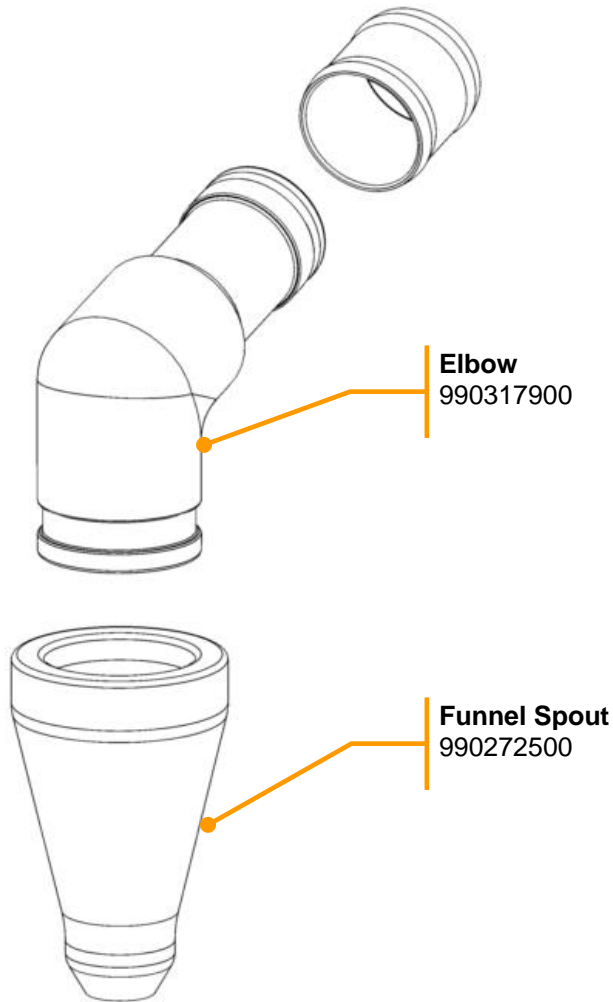
990318000 Spout Kit – Includes all components as pictured below





 4421 Waterfront Drive Glen Allen, VA 23060	Revision	Add SB960 and SB961 images and call outs to PAD.					Rev. Date:	
	Description:						Rev. Date:	
Request #:	DOC11607	Page:	10 of 17	Document #:	<b>540096100</b>	Rev:	<b>J</b>	

## Parts & Accessories Diagram - Model HJE960-CE

**PROPRIETARY RIGHTS NOTICE** This document and all information contained within it is the property of Hamilton Beach Brands, Inc. (HBB). It is confidential and proprietary and has been provided to you for a limited purpose. It must be returned or destroyed upon request. Disclosure, reproduction or use of this document and any information contained within it, in full or in part, for any purpose is forbidden without the prior written consent of HBB. No photographs may be taken of any article fabricated or assembled from this document without the prior written consent of HBB.

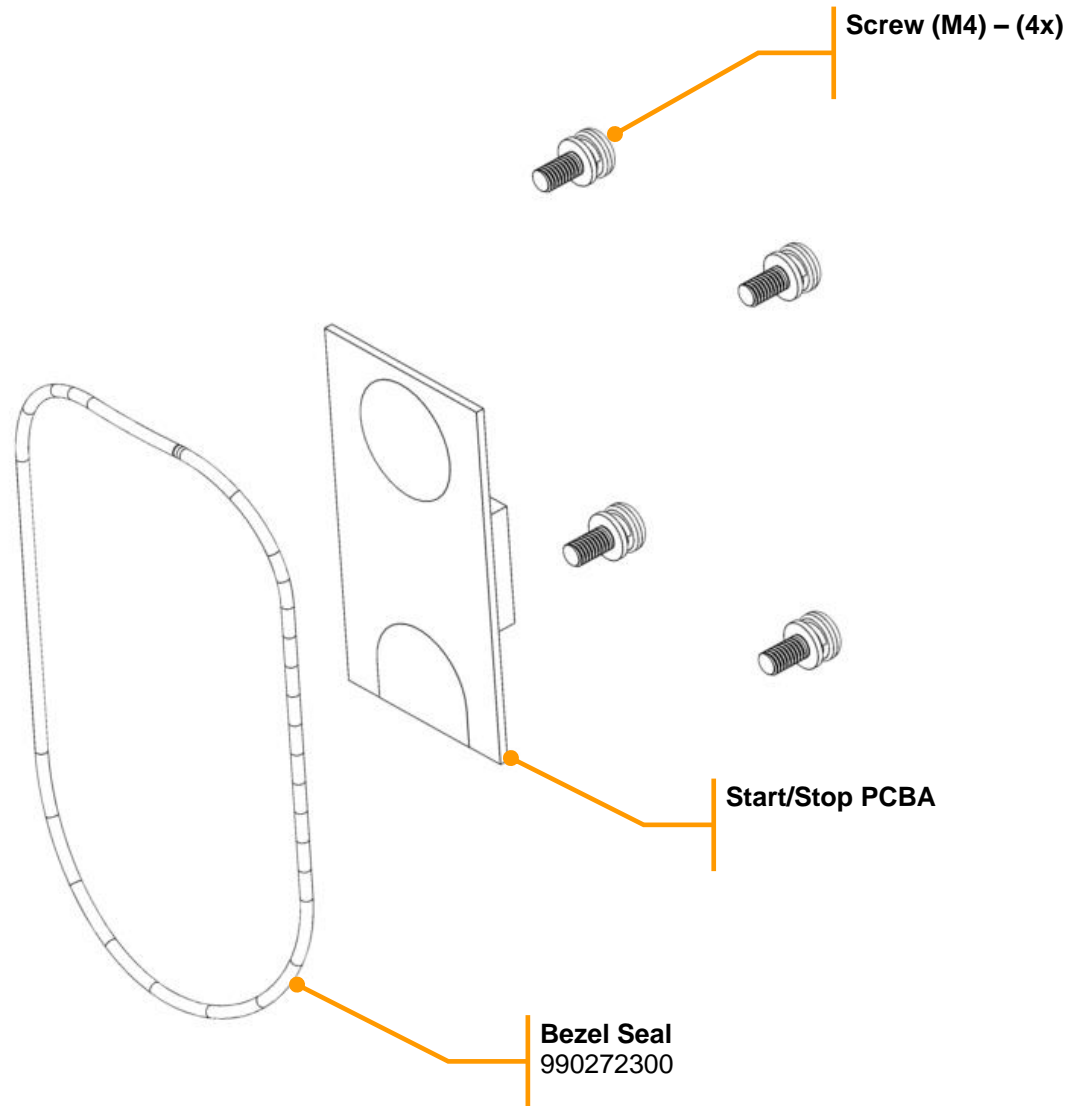
990274500 Start/Stop PCBA Kit – Includes all components as pictured below



 4421 Waterfront Drive Glen Allen, VA 23060	Revision	Add SB960 and SB961 images and call outs to PAD.					Rev. Date:	
	Description:						Rev. Date:	
Request #:	DOC11607	Page:	11 of 17	Document #:	<b>540096100</b>	Rev:	<b>J</b>	

## Parts & Accessories Diagram - Model HJE960-CE

**PROPRIETARY RIGHTS NOTICE** This document and all information contained within it is the property of Hamilton Beach Brands, Inc. (HBB). It is confidential and proprietary and has been provided to you for a limited purpose. It must be returned or destroyed upon request. Disclosure, reproduction or use of this document and any information contained within it, in full or in part, for any purpose is forbidden without the prior written consent of HBB. No photographs may be taken of any article fabricated or assembled from this document without the prior written consent of HBB.

990274601 Cord Kit (230V) – Includes all components as pictured below



**Strain Relief Grommet**  
990273600

 4421 Waterfront Drive Glen Allen, VA 23060	Revision	Add SB960 and SB961 images and call outs to PAD.					Rev. Date:	
	Description:						Rev. Date:	
Request #:	DOC11607	Page:	12 of 17	Document #:	<b>540096100</b>	Rev:	<b>J</b>	

## Parts & Accessories Diagram - Model HJE960-CE

**PROPRIETARY RIGHTS NOTICE** This document and all information contained within it is the property of Hamilton Beach Brands, Inc. (HBB). It is confidential and proprietary and has been provided to you for a limited purpose. It must be returned or destroyed upon request. Disclosure, reproduction or use of this document and any information contained within it, in full or in part, for any purpose is forbidden without the prior written consent of HBB. No photographs may be taken of any article fabricated or assembled from this document without the prior written consent of HBB.

990274701 PCBA Assembly – Includes all components as pictured below

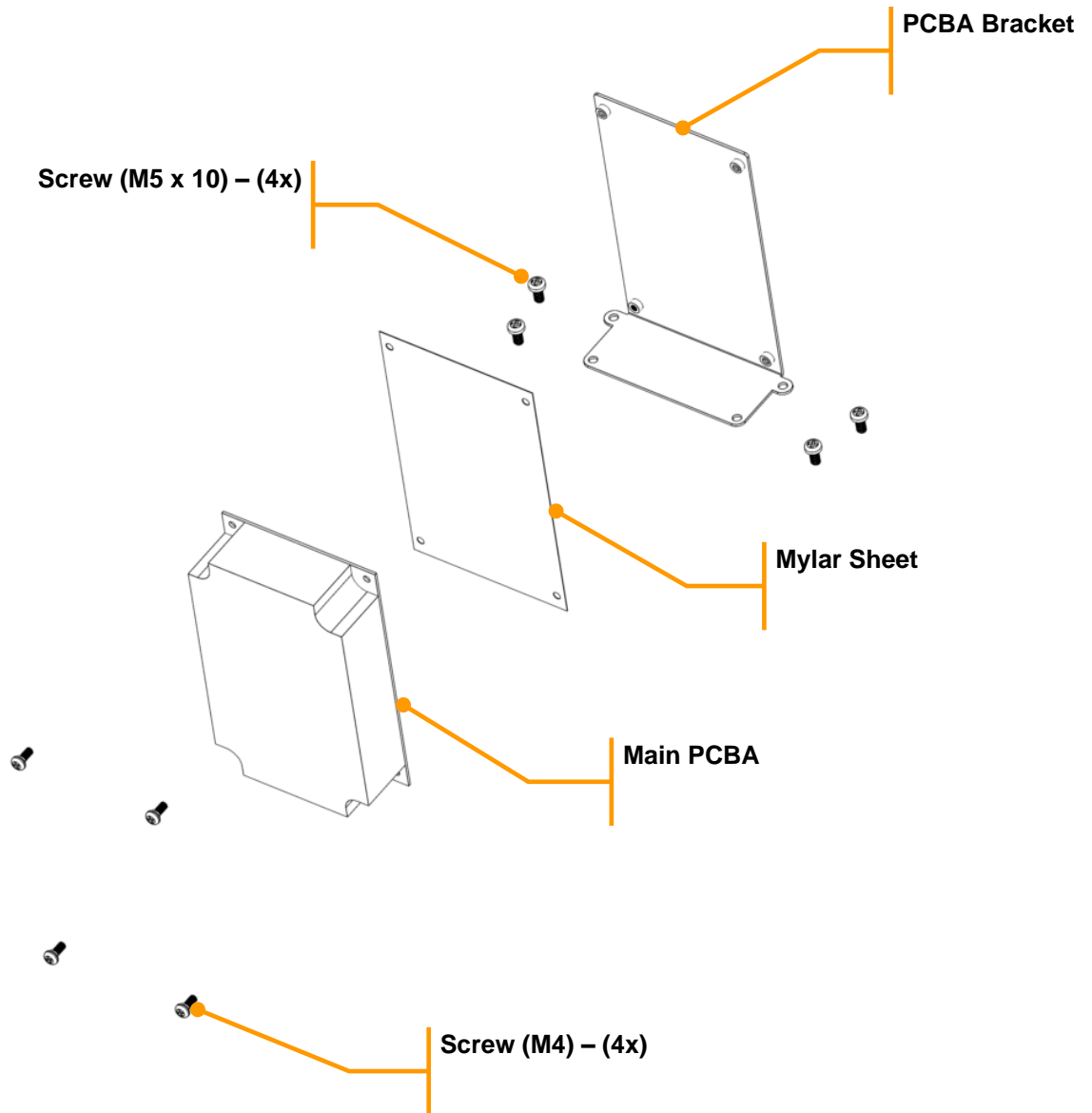



 <p>Hamilton Beach 4421 Waterfront Drive Glen Allen, VA 23060</p>	Revision	Add SB960 and SB961 images and call outs to PAD.				Rev. Date:	
	Description:					Rev. Date:	
Request #:	DOC11607	Page:	13 of 17	Document #:	540096100	Rev:	J

## Parts & Accessories Diagram - Model HJE960-CE

**PROPRIETARY RIGHTS NOTICE** This document and all information contained within it is the property of Hamilton Beach Brands, Inc. (HBB). It is confidential and proprietary and has been provided to you for a limited purpose. It must be returned or destroyed upon request. Disclosure, reproduction or use of this document and any information contained within it, in full or in part, for any purpose is forbidden without the prior written consent of HBB. No photographs may be taken of any article fabricated or assembled from this document without the prior written consent of HBB.

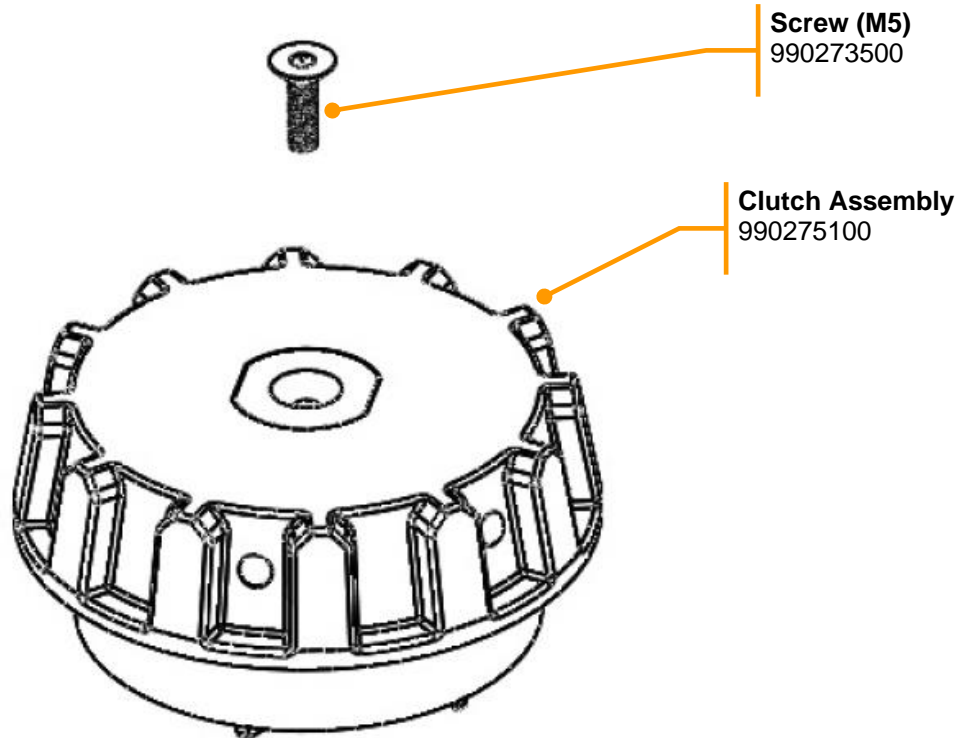
990272200 Clutch Kit – Includes all components as pictured below





 4421 Waterfront Drive Glen Allen, VA 23060	Revision	Add SB960 and SB961 images and call outs to PAD.					Rev. Date:	
	Description:						Rev. Date:	
Request #:	DOC11607	Page:	14 of 17	Document #:	<b>540096100</b>	Rev:	<b>J</b>	

## Parts & Accessories Diagram - Model HJE960-CE

**PROPRIETARY RIGHTS NOTICE** This document and all information contained within it is the property of Hamilton Beach Brands, Inc. (HBB). It is confidential and proprietary and has been provided to you for a limited purpose. It must be returned or destroyed upon request. Disclosure, reproduction or use of this document and any information contained within it, in full or in part, for any purpose is forbidden without the prior written consent of HBB. No photographs may be taken of any article fabricated or assembled from this document without the prior written consent of HBB.

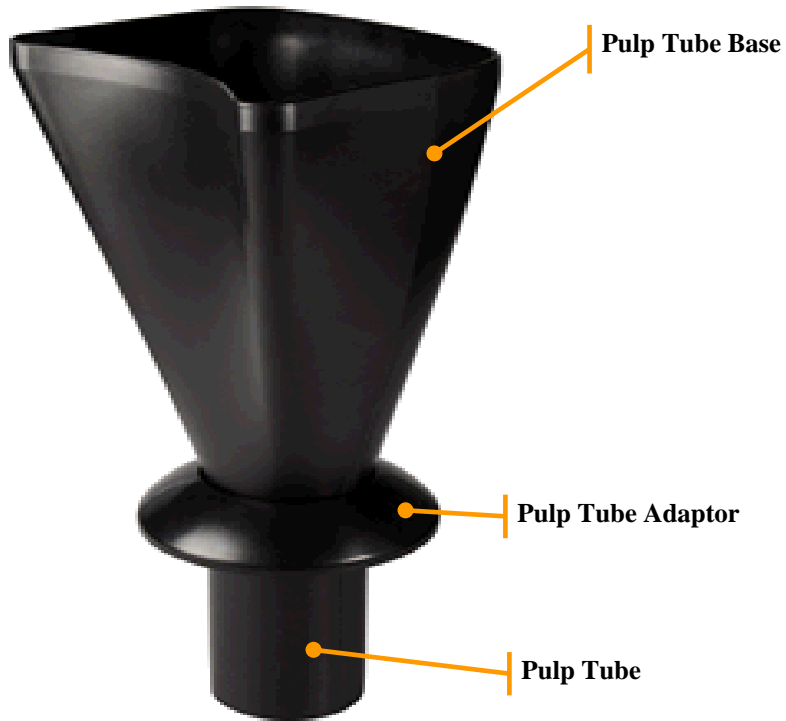
UTC960 – Includes all components as pictured below



 4421 Waterfront Drive Glen Allen, VA 23060	Revision	Add SB960 and SB961 images and call outs to PAD.					Rev. Date:	
	Description:						Rev. Date:	
Request #:	DOC11607	Page:	15 of 17	Document #:	<b>540096100</b>	Rev:	<b>J</b>	

## Parts & Accessories Diagram - Model HJE960-CE

**PROPRIETARY RIGHTS NOTICE** This document and all information contained within it is the property of Hamilton Beach Brands, Inc. (HBB). It is confidential and proprietary and has been provided to you for a limited purpose. It must be returned or destroyed upon request. Disclosure, reproduction or use of this document and any information contained within it, in full or in part, for any purpose is forbidden without the prior written consent of HBB. No photographs may be taken of any article fabricated or assembled from this document without the prior written consent of HBB.

### Accessories

**Strainer Baskets:**

**SB960 for Normal “Wet” Foods**

**SB961 for Green Leafy Vegetables (i.e. Kale, Spinach, etc.)**



**SB960**

Enlarged view of SB960 hole pattern.



**SB961**

Enlarged view of SB961 hole pattern.



 4421 Waterfront Drive Glen Allen, VA 23060	Revision	Add SB960 and SB961 images and call outs to PAD.				Rev. Date:
	Description:	DOC11607	Page:	16 of 17	Document #:	04/02/2021
	Request #:				540096100	Rev: <b>J</b>



## Parts & Accessories Diagram - Model HJE960-CE

**PROPRIETARY RIGHTS NOTICE** This document and all information contained within it is the property of Hamilton Beach Brands, Inc. (HBB). It is confidential and proprietary and has been provided to you for a limited purpose. It must be returned or destroyed upon request. Disclosure, reproduction or use of this document and any information contained within it, in full or in part, for any purpose is forbidden without the prior written consent of HBB. No photographs may be taken of any article fabricated or assembled from this document without the prior written consent of HBB.

### SB960 & SB961 Accessory Strainer Baskets – Parts Breakdown

**Please Note: SB960 & SB961 – Include all components as pictured below**

**Screw (M6 x 16)**  
Qty. 3  
990272000



**Grating Disc**  
990271500

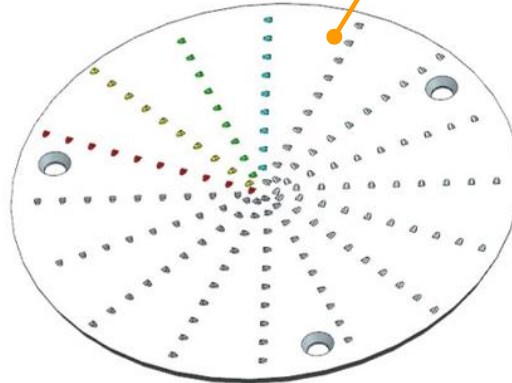

**Basket Base**  
990271700

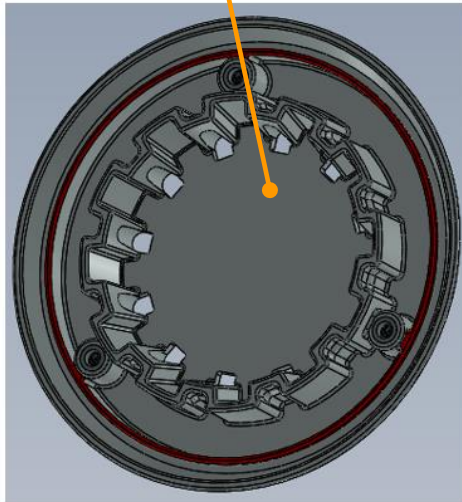

**Strainer Basket**  
990318100 (SB961)  
990271600 (SB960)

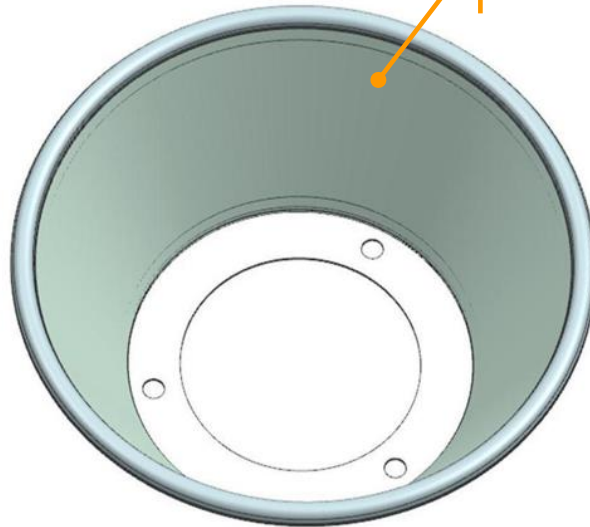

 4421 Waterfront Drive Glen Allen, VA 23060	Revision	Add SB960 and SB961 images and call outs to PAD.				Rev. Date:
	Description:					Rev. Date:
Request #:	DOC11607	Page:	17 of 17	Document #:	540096100	Rev: J