

Drawing



Tools for Chefs

Hendi B.V.

Steenoven 21
3911 TX Rhenen
The Netherlands

Batch #

000000 and up

Appliance part#

226001

Description

Kebab grill gas Profi Line

Date 20-09-2023

Revision #

1.0

Revision First Bill of Materials (BOM)



Bill of materials (BOM)

 <b style="font-size: 24px; margin-left: 10px;">HENDI <small style="color: green; margin-left: 10px;">Tools for Chefs</small> Hendi B.V. Steenoven 21 3911 TX Rhenen The Netherlands	Batch #	Appliance part#
	000000 and up	226001
	Description	
	Kebab grill gas Profi Line	

Date	20-09-2023	Revision #	1.0
Revision	First Bill of Materials (BOM)		

Item	Description	Part#	Quantity	Remark	Picture
1	Frame	n/a	1		
2	Heater	n/a	4		
3	Knob	929650	4		
4	Motor	936856	1		
5	Switch	941416	1		
6	Motor handle	n/a	1		
7	Motor arm	n/a	1		
8	Skewer lock	n/a	1		
9	Skewer	929179	1		
10	Skewer holder	n/a	1		
11	Bottom handle	n/a	1		
12	Tray	n/a	1		

n/a -> not available

nss -> not sold separately

Drawing



Tools for Chefs

Hendi B.V.
 Steenoven 21
 3911 TX Rhenen
 The Netherlands

Batch #	Appliance part#
000000 and up	226001

Description
Kebab grill gas Profi Line

Date	20-09-2023	Revision #	1.0
Revision	First Bill of Materials (BOM)		



Bill of materials (BOM)

 <b style="font-size: 24px; margin-left: 10px;">HENDI <small style="color: green; margin-left: 10px;">Tools for Chefs</small> Hendi B.V. Steenoven 21 3911 TX Rhenen The Netherlands	Batch #	Appliance part#
	000000 and up	226001
	Description	
	Kebab grill gas Profi Line	

Date	20-09-2023	Revision #	1.0
Revision	First Bill of Materials (BOM)		

Item	Description	Part#	Quantity	Remark	Picture
1	Gas valve	929605	4		
2	Heater	n/a	4		
3	Heater gas pipe	n/a	4		
4	Holder	n/a	4		
5	Gas pipe nipple	n/a	4		
6	Gas pipe seal	n/a	4		
7	By-pass injector (natural gas)	929629	4		
7A	By-pass injector (propane gas)	929612	0		
8	Injector (natural gas)	929643	4		
9	Injector holder	n/a	1		
10	Injector (propane gas)	929636	0		
11	Skewer plate holder (small)	n/a	1		
12	Meat plate	n/a	1		
13	Skewer plate holder (large)	964224	1		
14	Side screen	n/a	1		
15	Skewer lock pin	n/a	1		
16	Electrode with wiring	n/a	1		
17	Piezo igniter	153178	4		

n/a -> not available

nss -> not sold separately

Drawing



Tools for Chefs

Hendi B.V.
Steenoven 21
3911 TX Rhenen
The Netherlands

Batch #
000000 and up

Appliance part#
226001

Description
Kebab grill gas Profi Line

Date	20-09-2023	Revision #	1.0
Revision	First Bill of Materials (BOM)		

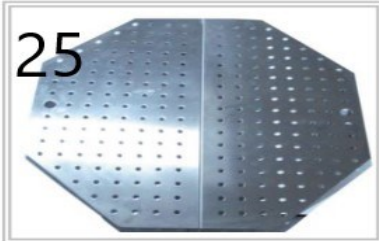
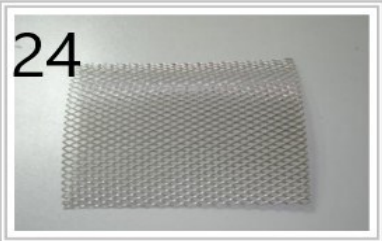
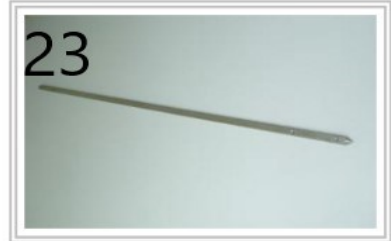
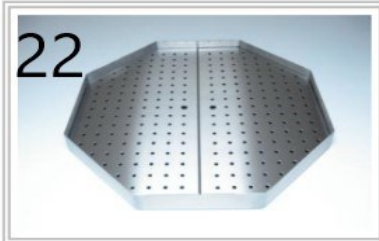
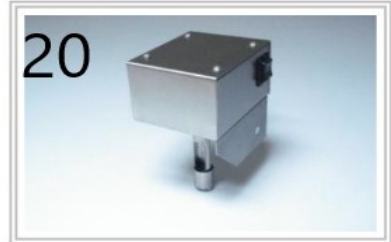

Bill of materials (BOM)

 HENDI Tools for Chefs Hendi B.V. Steenoven 21 3911 TX Rhenen The Netherlands	Batch #	Appliance part#
	000000 and up	226001
	Description	
Kebab grill gas Profi Line		

Date	20-09-2023	Revision #	1.0
Revision	First Bill of Materials (BOM)		

Item	Description	Part#	Quantity	Remark	Picture
1	Bottom handle	n/a	1		
2	Top handle	947999	1		
3	Motor	936856	1		
4	Thermocouple	929599	1		
5	Tray	n/a	1		
6	Skewer	929179	1		
7	Heater cover	n/a	4		
8	Drip tray	n/a	1		

n/a -> not available

nss -> not sold separately

Circuit diagram

 <b style="font-size: 24px; margin-left: 10px;">HENDI Tools for Chefs Hendi B.V. Steenoven 21 3911 TX Rhenen The Netherlands	Batch #	Appliance part#
	000000 and up	226001
	Description	
	Kebab grill gas Profi Line	

Date	20-09-2023	Revision #	1.0
Revision	First Bill of Materials (BOM)		

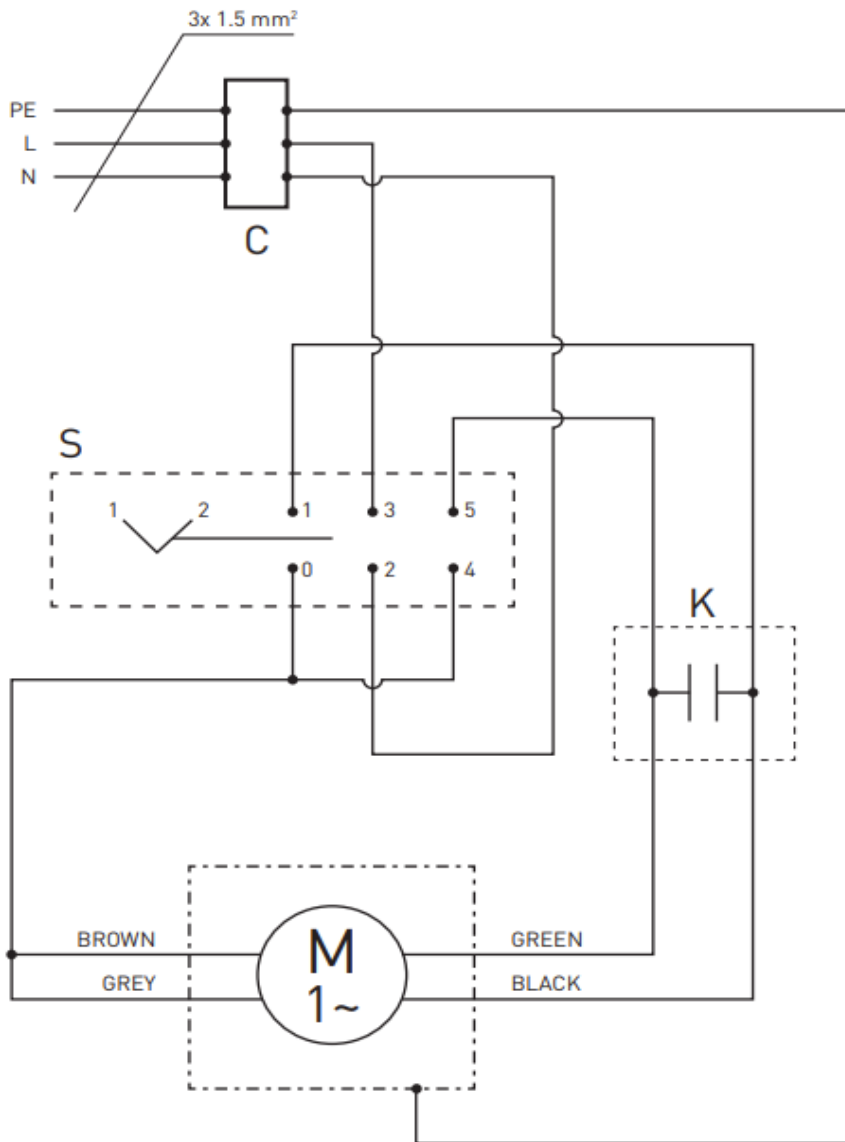

M = motor
 S = control switch
 K = capacitor
 C = connecting device