

Drawing



Tools for Chefs

Hendi B.V.
Steenoven 21
3911 TX Rhenen
The Netherlands

Batch #

000000 and up

Appliance part#

226636

Description

Electric dough roller 400

Date 11-06-2020

Revision #

1.0

Revision First Bill of Materials (BOM)

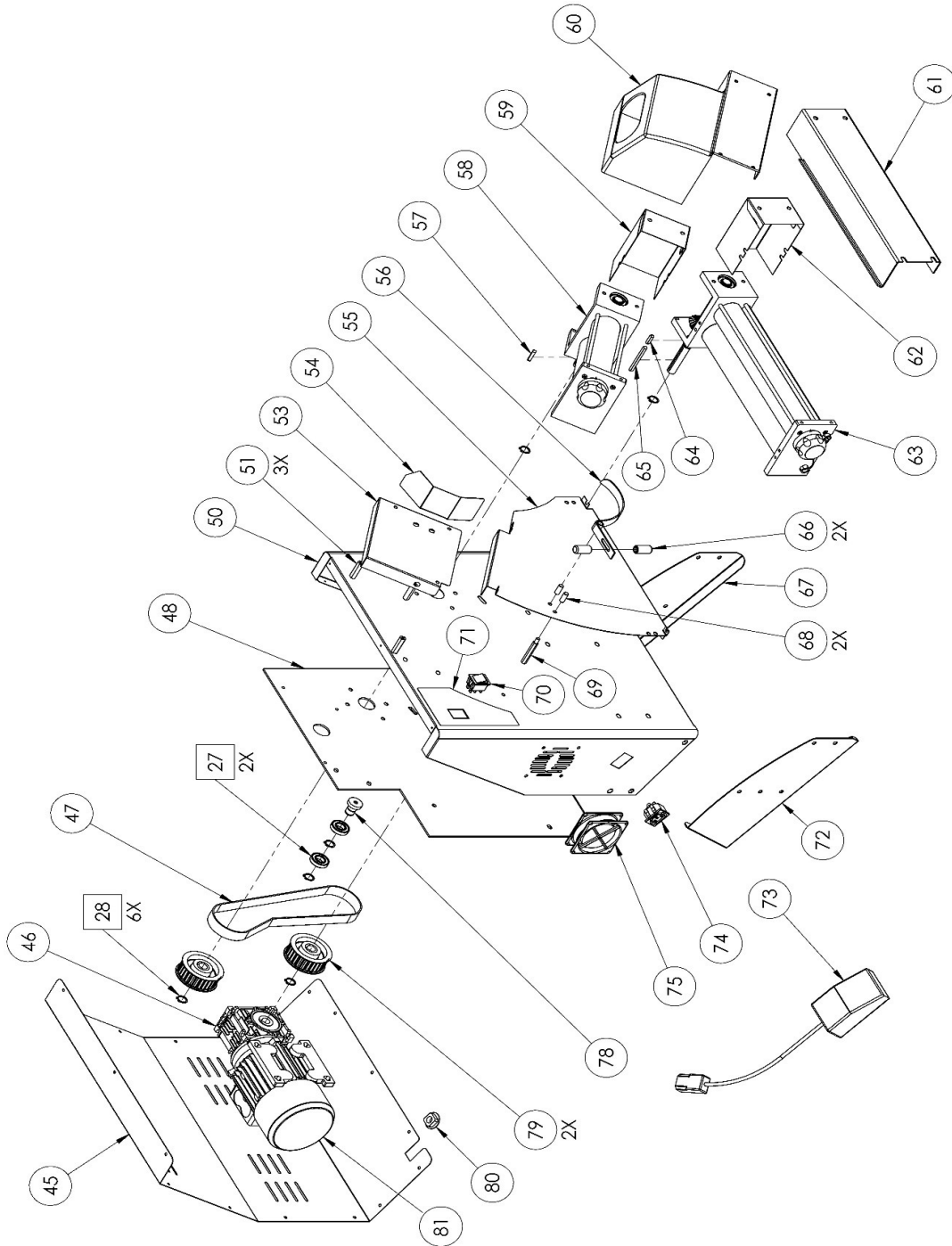

Bill of materials (BOM)

 <b style="font-size: 24px; margin-left: 10px;">HENDI <small style="color: green; margin-left: 10px;">Tools for Chefs</small> Hendi B.V. Steenoven 21 3911 TX Rhenen The Netherlands	Batch #	Appliance part#
	000000 and up	226636
	Description	
	Electric dough roller 400	

Date	11-06-2020	Revision #	1.0
Revision	First Bill of Materials (BOM)		

Item	Description	Part#	Quantity	Remark	Picture
27	Bearing	n/a	2		
28	Seeger ring	n/a	2		
45	Housing panel (back)	n/a	1		
46	Transmission	n/a	1		
47	Drive belt	n/a	1		
48	Mounting bracket	n/a	1		
50	Frame	n/a	1		
51	Stand-off	n/a	3		
53	Upper dough slide	n/a	1		
54	Upper guide bracket	n/a	1		
55	Lower dough slide	n/a	1		
56	Rocker arm	n/a	1		
57	Key (5x5x25mm)	n/a	1		
58	Upper roller group	n/a	1	See Drawing 2	
59	Gearbox cover (upper roller group)	n/a	1		
60	Protective cover upper roller group	n/a	1		
61	Protective cover lower roller group	n/a	1		
62	Gearbox cover (lower roller group)	n/a	1		
63	Lower roller group	n/a	1	See Drawing 3	
64	Key (5x5x20mm)	n/a	1		
65	Key (5x5x60mm)	n/a	1		
66	Counterweight rocker arm	n/a	1		
67	Foot (right)	n/a	1		
68	Stand-off (rocker arm)	n/a	2		
69	Stand-off (lower dough slide)	n/a	1		
70	Switch	n/a	1		
71	Display sticker	n/a	1		
72	Foot (left)	n/a	1		
73	Foot pedal	936245	1		
74	Foot pedal socket	n/a	1		
75	Fan	n/a	1		
78	Belt tensioner	n/a	1		
79	Pulley	n/a	2		
80	Pull relief	n/a	1		
81	Motor (230V, 0.25kW)	n/a	1		

n/a -> not available

nss -> not sold separately

Drawing



Tools for Chefs

Hendi B.V.
Steenoven 21
3911 TX Rhenen
The Netherlands

Batch #
000000 and up

Appliance part#
226636

Description
Electric dough roller 400

Date	11-06-2020	Revision #	1.0
Revision	First Bill of Materials (BOM)		

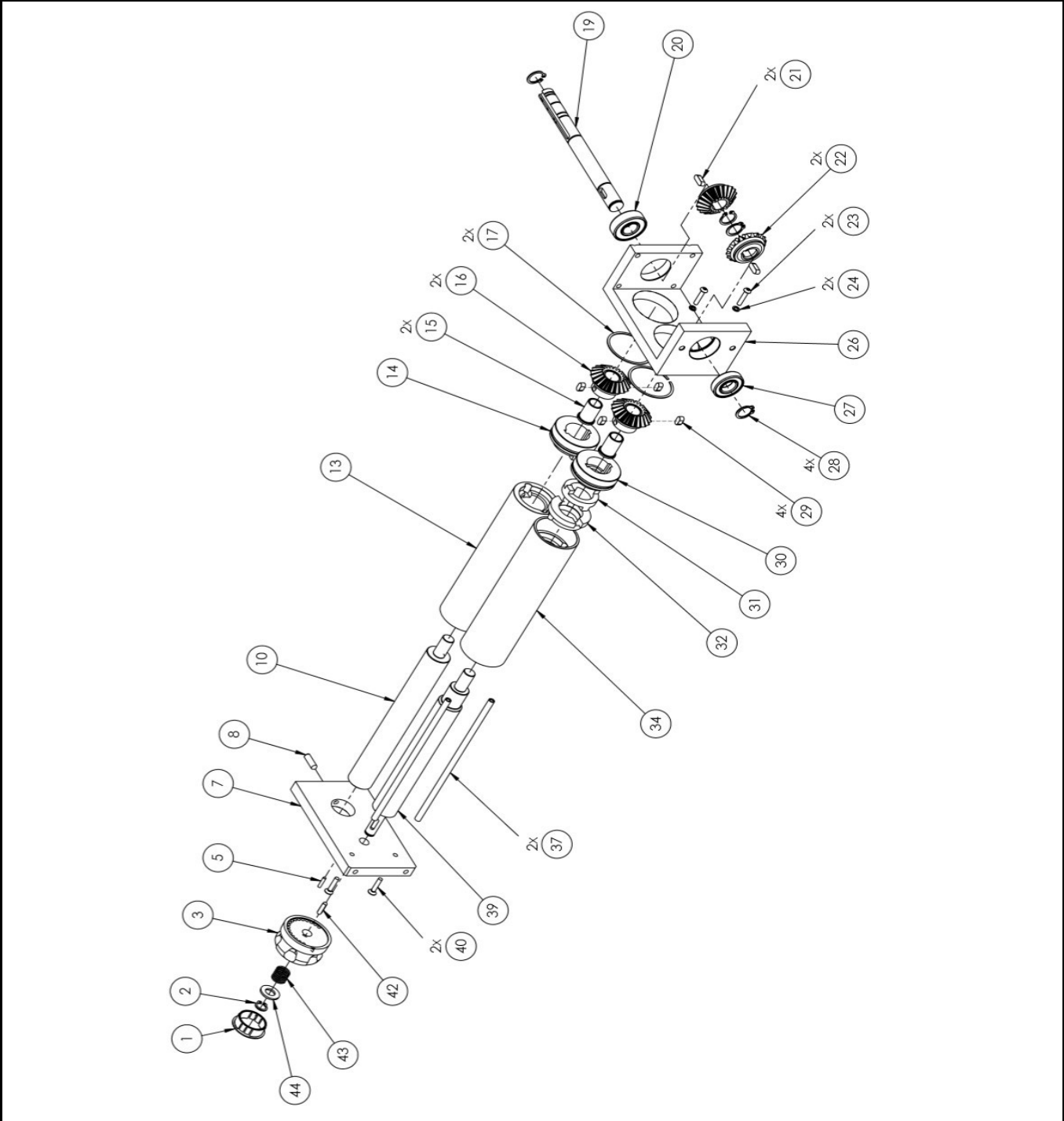

Bill of materials (BOM)

 HENDI Tools for Chefs Hendi B.V. Steenoven 21 3911 TX Rhenen The Netherlands	Batch #	Appliance part#
	000000 and up	226636
	Description	
	Electric dough roller 400	

Date	11-06-2020	Revision #	1.0
Revision	First Bill of Materials (BOM)		

Item	Description	Part#	Quantity	Remark	Picture
1	Knob plug	n/a	1		
2	Seeger ring	n/a	1		
3	Knob	n/a	1		
5	Locking pin	n/a	1		
7	Roller bracket	n/a	1		
10	Cilindric roller shaft	n/a	1		
13	Cilindric roller	n/a	1		
14	Gear duct (cilindric)	nss	1	Available as 941829	
15	Gear duct shaft	nss	2	Available as 941829 and 941836	
16	Bevel gear	nss	2	Available as 941829 and 941836	
17	Ring	n/a	2		
19	Drive shaft	n/a	1		
20	Bearing	n/a	1		
21	Key (5x5x14mm)	n/a	2		
22	Drive bevel gear	n/a	2		
23	Screw	n/a	2		
24	Washer	n/a	2		
26	Gear box	n/a	1		
27	Bearing	n/a	1		
28	Seeger ring	n/a	1		
29	Key (5x5x10mm)	nss	4	Available as 941829 and 941836	
30	Gear duct (eccentric)	nss	1	Availalbe as 941836	
31	Coupler (male)	n/a	1		
32	Coupler (female)	n/a	1		
34	Eccentric roller	n/a	1		
37	Support rod	n/a	2		
39	Eccentric roller shaft	n/a	1		
40	Screw	n/a	2		
42	Key (4x4x15mm)	n/a	1		
43	Knob spring	n/a	1		
44	Washer	n/a	1		
*	Gear set complete (cilindric roller)	941829	1	Incl. item 14, 15, 16 and 29	
*	Gear set complete (eccentric roller)	941836	1	Incl. item 15, 16, 29 and 30	

n/a -> not available

nss -> not sold separately

Drawing



Tools for Chefs

Hendi B.V.
 Steenoven 21
 3911 TX Rhenen
 The Netherlands

Batch #
 000000 and up

Appliance part#
 226636

Description
 Electric dough roller 400

Date	11-06-2020	Revision #	1.0
Revision	First Bill of Materials (BOM)		

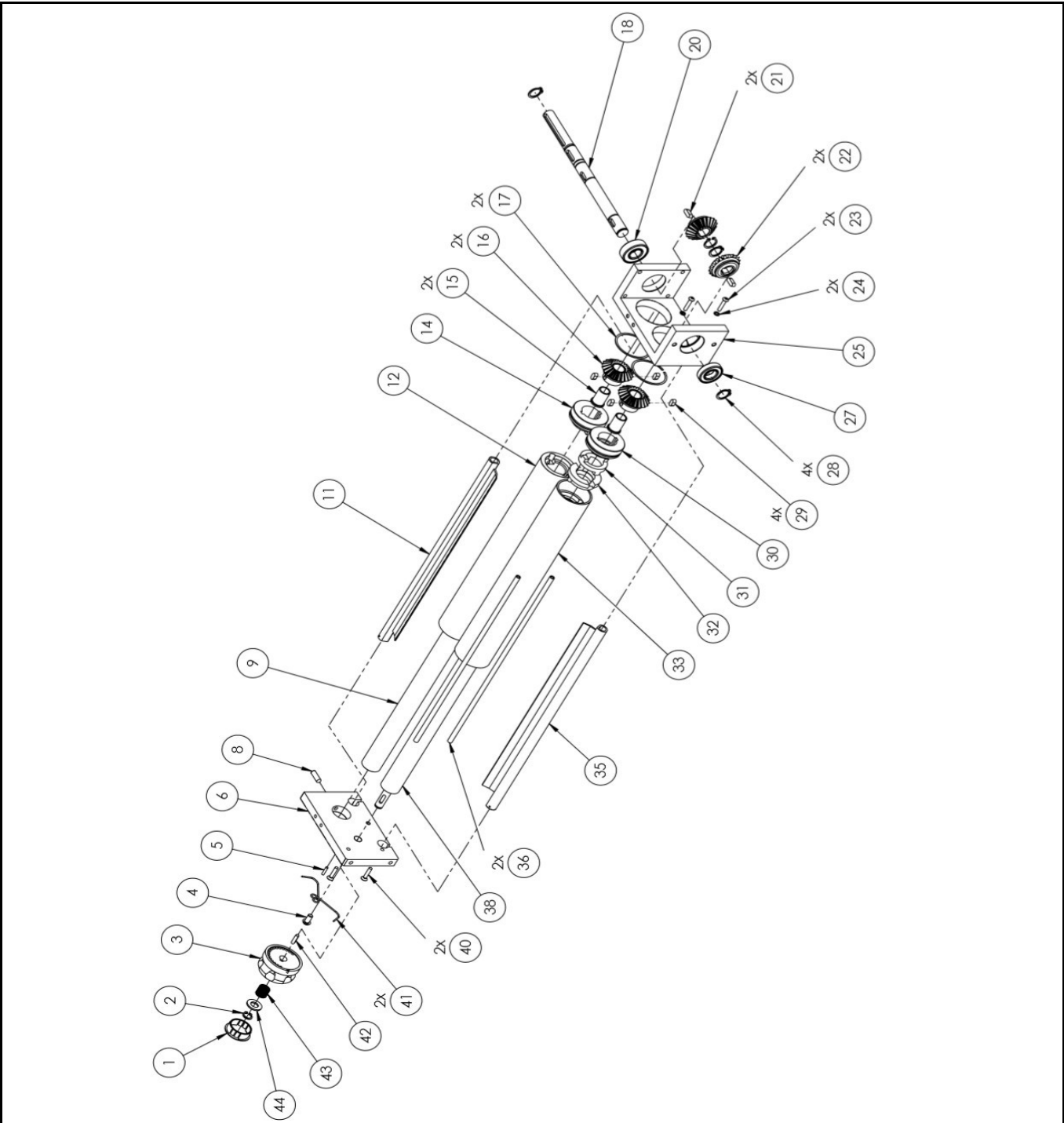

Bill of materials (BOM)

 HENDI Tools for Chefs Hendi B.V. Steenoven 21 3911 TX Rhenen The Netherlands	Batch #	Appliance part#
	000000 and up	226636
	Description	
	Electric dough roller 400	

Date	11-06-2020	Revision #	1.0
Revision	First Bill of Materials (BOM)		

Item	Description	Part#	Quantity	Remark	Picture
1	Knob plug	n/a	1		
2	Seeger ring	n/a	1		
3	Knob	n/a	1		
4	Screw	n/a	1		
5	Locking pin	n/a	1		
6	Roller bracket	n/a	1		
8	Pin	n/a	1		
9	Cilindric roller shaft	n/a	1		
11	Dought scraper (back)	n/a	1		
12	Cilindric roller	n/a	1		
14	Gear duct (cilindric)	nss	1	Available as 941829	
15	Gear duct shaft	nss	2	Available as 941829 and 941836	
16	Bevel gear	nss	2	Available as 941829 and 941836	
17	Ring	nss	2		
18	Drive shaft	n/a			
20	Bearing	n/a	1		
21	Key (5x5x14mm)	n/a	2		
22	Drive bevel gear	n/a	2		
23	Screw	n/a	2		
24	Washer	n/a	2		
25	Gear box	n/a	1		
27	Bearing	n/a	1		
28	Seeger ring	n/a	1		
29	Key (5x5x10mm)	n/a	4	Available as 941829 and 941836	
30	Gear duct (eccentric)	nss	1	Availalbe as 941836	
31	Coupler (male)	nss	1		
32	Coupler (female)	nss	1		
33	Eccentric roller	n/a	1		
35	Dough scraper (front)	n/a	1		
36	Support rod	n/a	2		
38	Eccentric roller shaft	n/a	1		
40	Screw	n/a	2		
41	Dough scaper spring	n/a	2		
42	Key (4x4x15mm)	n/a	1		
43	Knob spring	n/a	1		
44	Washer	n/a	1		
*	Gear set complete (cilindric roller)	941829	1	Incl. item 14, 15, 16 and 29	
*	Gear set complete (eccentric roller)	941836	1	Incl. item 15, 16, 29 and 30	

n/a -> not available

nss -> not sold separately

Wiring diagram

 HENDI Tools for Chefs Hendi B.V. Steenoven 21 3911 TX Rhenen The Netherlands	Batch #	Appliance part#
	000000 and up	226636
	Description	
	Electric dough roller 400	

Date	11-06-2020	Revision #	1.0
Revision	First Bill of Materials (BOM)		

